

Replacement Tube Bundles



Cemline Replacement Tube Bundles for Storage Water Heaters and Heat Exchangers

Constructed as an exact replacement for all existing tube bundles

- *Readily available*
- *Steam Bundles*
- *Boiler Water Bundles*
- *High Temperature Water Bundles*
- *Double Wall Tube Bundles*



1 Week Shipment

CEMLINE CORPORATION

P.O. BOX 55 CHESWICK, PENNSYLVANIA 15024
Phone: (724) 274-5430 FAX: (724) 274-5448

www.cemline.com

Guide to Ordering Replacement Tube Bundle

Figure 1
Tube Bundle

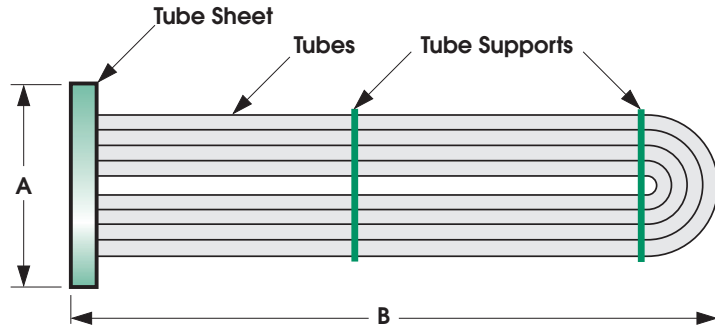
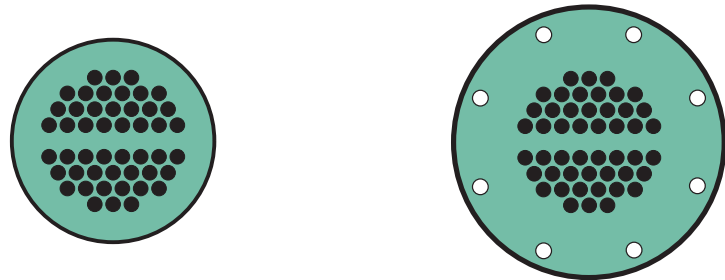

Figure 2
Tube Sheet Design



Between the Bolt Tube Sheet

Full Face Tube Sheet (Optional)

Figure 3
Tube Bundle Mounting

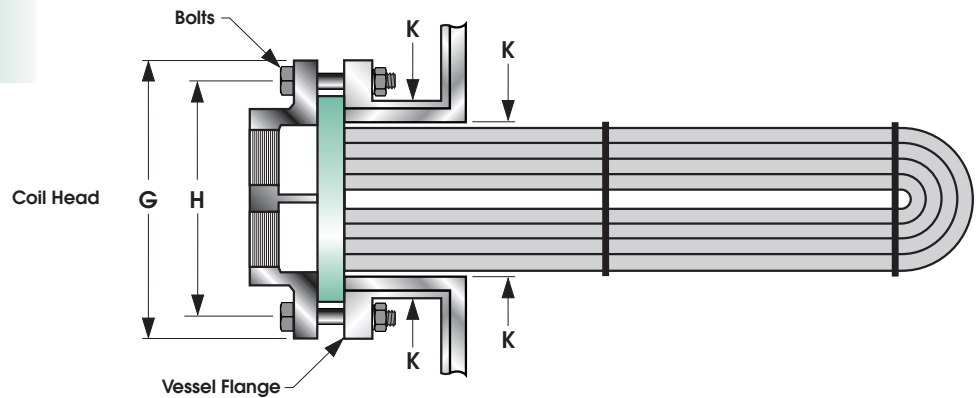
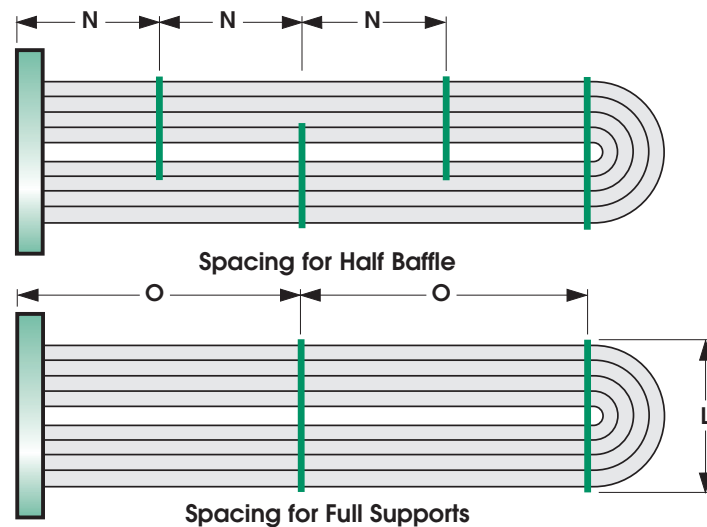
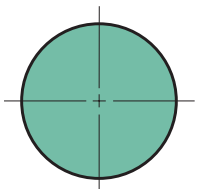
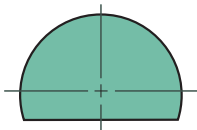

Figure 4
Tube Supports



Replacement Tube Bundle

In order to fabricate a replacement bundle for a heat exchanger or tank submerged heater bundle, the following information is required. Refer to page 2.

- Figure 1**.....**A.** O.D. of tube sheet
- B.** Length of bundle
 - C.** Diameter of tubes. 3/4" O.D. tubing is standard and commonly used. Existing coils with other size tubes (1" or 1 1/4" O.D.) can be replaced with 3/4" tube coils at no loss of operating efficiency.
 - D.** Material of tube sheet. If existing tube sheet is brass we recommend a replacement bundle with copper lined tube sheet.

- Figure 2**.....**E.** Style of tube sheet required between the bolt or full face. We normally furnish the between the bolt tube sheet. A full face tube sheet can be replaced with between the bolt style with no loss of operating efficiency.
- F.** If the existing bundle is accessible, a rubbing of the tube end can assure an exact replacement. Place a piece of paper against the tube sheet and rub over with a lead pencil. This transfer should then be sent with your order.

- Figure 3**.....**G.** O.D. of flange or circumference of flange.
- H.** Bolt circle of flange. If the is impractical to measure, indicate the center to center distance of two adjacent bolts.
 - I.** Size of bolts — (5/8", 3/4", 7/8", etc.)
 - J.** Number of bolts in flange.
 - K.** I.D. of neck or O.D. of neck-or-circumference of neck.

- Figure 4**.....**L.** Maximum O.D. of tube supports.
- M.** For heat exchanger, type of tube support steel or copper.
 - N.** For heat exchanger, spacing of tube supports.
 - O.** For tank heater, number of spacers and dimension from rear of tube sheet to center of spacers.

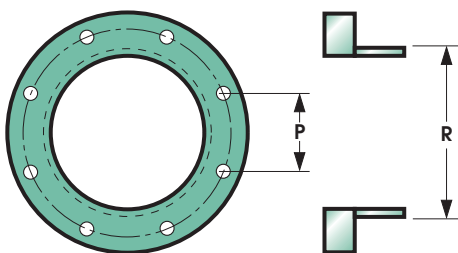

Often it is impossible to measure all of these dimensions while the unit is in service. We can manufacture a coil to fit when provided with the following minimum information.

- P.** Center to center of head bolts.
- Q.** Number of bolts.
- R.** O.D. of neck or circumference of neck.
- S.** Length of unit. If unknown, measure the length of vessel or maximum length available to remove bundle.

Replacement Submerged Tube Bundles Material Specification



Cemline standard replacement tube bundles are designed for a maximum working pressure of 150 psig and temperature of 375° F. Normal construction and various options are outlined below.

Standard Replacement Submerged Bundle

Features

Tube Sheet.....	Tube Sheets are precision drilled of specification grade steel. Normally the between bolt tube sheet is furnished. (A between the bolt tube sheet can be used to replace a full tube sheet at no loss of operating efficiency.)
Tubes.....	Seamless deoxidized first quality copper tubes, 3/4" O.D. precision bent and rolled into tube sheet with torque controlled expander to assure proper tube seating. (An existing bundle with 1" or 1 1/4" O.D. tubing can be replaced with 3/4" O.D. tubing at no loss of operating efficiency.)
Spacers.....	Copper or steel spacers are precision fabricated to keep tubes in perfect alignment.
Gaskets.....	Die cut compressed gasketing material suitable up to 750°F.
Testing.....	Each coil individually hydrostatically tested to assure final quality.
Warranty.....	Each coil has a warranty for one (1) year after start up.

Options available

Copper lined tube sheet..... (recommended for Domestic water.)	Economical, yet effective method of protecting water face of tube sheet. A 16 ounce copper sheet is bonded to steel tube sheet to assure a lifetime of rust free water.
Tubing (Single Wall).....	For applications where required, we can furnish 90:10 Cupro Nickel, admiralty brass, or stainless steel tubes built with the same care and same quality as our standard coils. Cemline also stocks 1/2" O.D. tubing — 3/8" and 5/8" O.D. tubing are available upon request.
Tubing (Double Wall).....	Some building codes require vented double wall coils to guard against cross contamination of potable water. Cemline offers these coils with copper inner/copper outer or copper-nickel inner/copper outer tubes.
Solid Brass (or other non-ferrous..... tube sheets.)	We recommend copper lined tube sheets as the most suitable, however other special non-ferrous tube sheets are available.
Fabricated steel heads.....	A fabricated steel head can be furnished to replace existing coil head.
Working pressure — 400 psig..... Temperature — 450°F.	Cemline coils can be fabricated for 400 psig working pressure at 450°F. for high temperature hot water or high pressure steam.
Full face tube sheet.....	At customer request, Cemline can furnish a full face tube sheet. Adds to cost and extends delivery.
Retube or repair.....	Cemline can also retube or repair your existing tube bundle.

